



Copyright 2011 SMA

*Visual Interpretation of the*  
**STAIR BUILDING CODE**  
**2009 International**  
**Residential Code**

Portions of this publication reproduce excerpts from the *2009 International Residential Code for One-and Two-Family Dwellings* and *2009 International Building Code*, International Code Council, Inc., Washington, D.C. Reproduced with permission. All rights reserved. [www.iccsafe.org](http://www.iccsafe.org)

© 2010 SMA, 877-500-5759 First Edition

[www.stairways.org](http://www.stairways.org)

## About this Document

---

The Stairway Manufacturers Association publishes visual interpretations of Building Codes to be accurate pictorial material void of editorial comment to aid in the understanding of the written code text. We provide this document as a learning tool to aid designers, builders, homeowners, building officials, stair builders, and others in the shelter industry to accurately and consistently interpret the building code related to stairways.

The SMA has participated in the model code development process since 1988. We support the International Code Council's (ICC) development process through our membership and are recognized and respected for our responsible efforts at code reform and interpretation in addition to our trade and industry experience that we bring to the table. This experience and reputation is an asset to our continued efforts to provide safe stairways and reduce stairway accidents while allowing freedom of design, and aesthetic properties of preference.

In addition to our experience in the code development process we provide technical writing and graphics assistance related to the IRC and IBC Code Commentaries as published by the ICC for each edition.

The SMA wishes to thank the ICC for their permission to print portions of the IRC and in full recognition of our responsibility to educate and inform we invite your feedback and comments.

This document is provided electronically to those who wish to download it from [www.stairways.org](http://www.stairways.org). It may only be printed in whole and is not to be copied or used in part by any means or in any other publication. Printed copies are available only from the SMA. This document is not to be posted on any website except by permission of the SMA to use an authorized link.

## To the User

---

If you find this document to be of significant value, then you will find it equally beneficial to associate with a member of the Stairway Manufacturer's Association (SMA). The members of the SMA have taken on the task of influencing the development of responsible and functional building codes. They are the very individuals effectively communicating consistent interpretation of each stair code. A resulting product of their effort is this Visual Interpretation. SMA members know their craft of Stair Design and Construction and they know Building Codes. You are encouraged to contact a member of the SMA before you begin your next stairway project. Our Members proudly display the "SMA Member" logo.



**The Stair Industry  
Dedicated to Safety & Quality**

## Consider Membership

---

If your work is related to stairs and you can prescribe to the ethics and quality standards of the SMA you may qualify for membership.

To learn more about the SMA go to our website [www.stairways.org](http://www.stairways.org), and [contact us](#) or call toll free 877-500-5759.

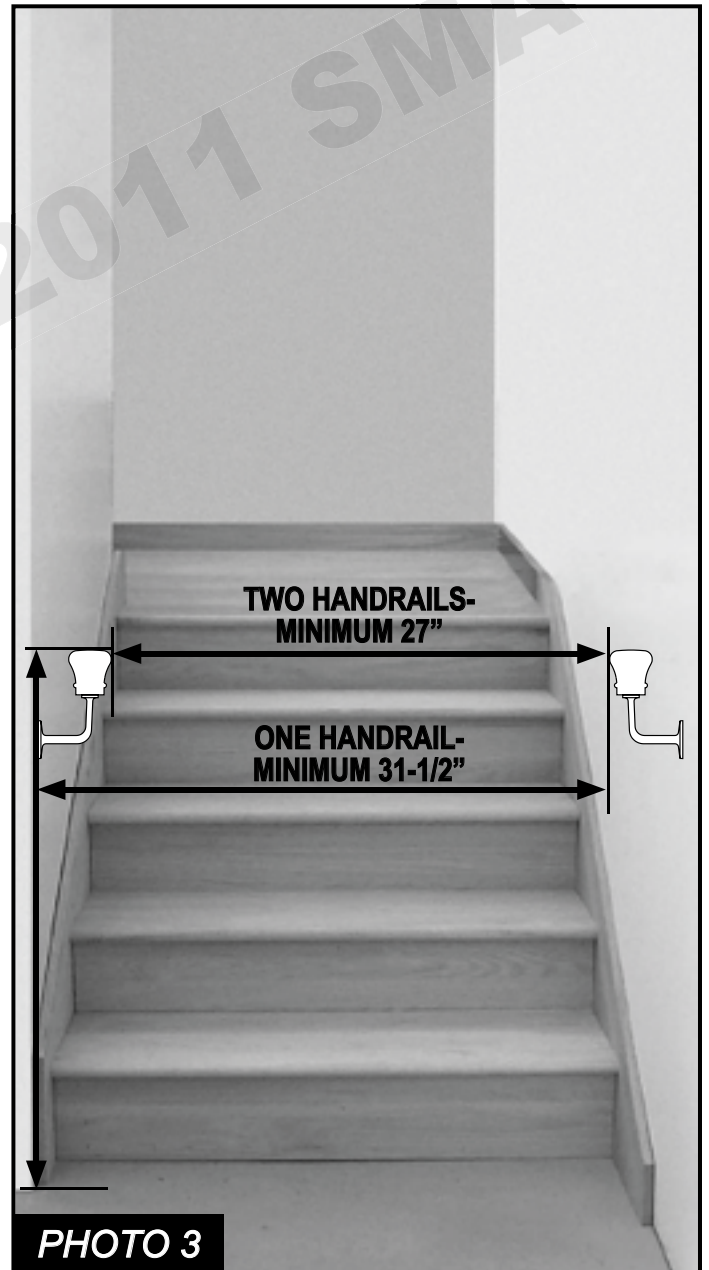
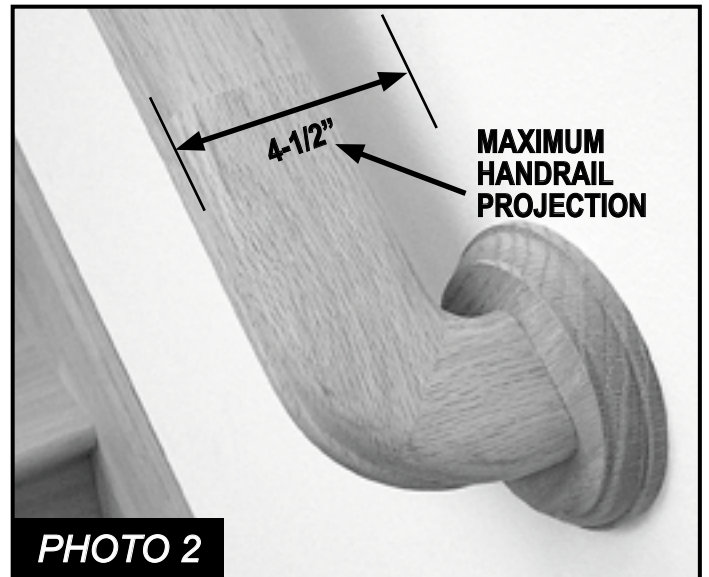
## SECTION R311.7 STAIRWAYS

### R311.7.1 Width.

Stairways shall not be less than 36 inches (914 mm) in clear width at all points above the permitted *handrail* height and below the required headroom height.

**PHOTO 1.** Handrails shall not project more than 4.5 inches (114 mm) on either side of the *stairway* **PHOTO 2** and the minimum clear width of the *stairway* at and below the *handrail* height, including treads and landings, shall not be less than 31½ inches (787 mm) where a *handrail* is installed on one side and 27 inches (698 mm) where *handrails* are provided on both sides **PHOTO 3**.

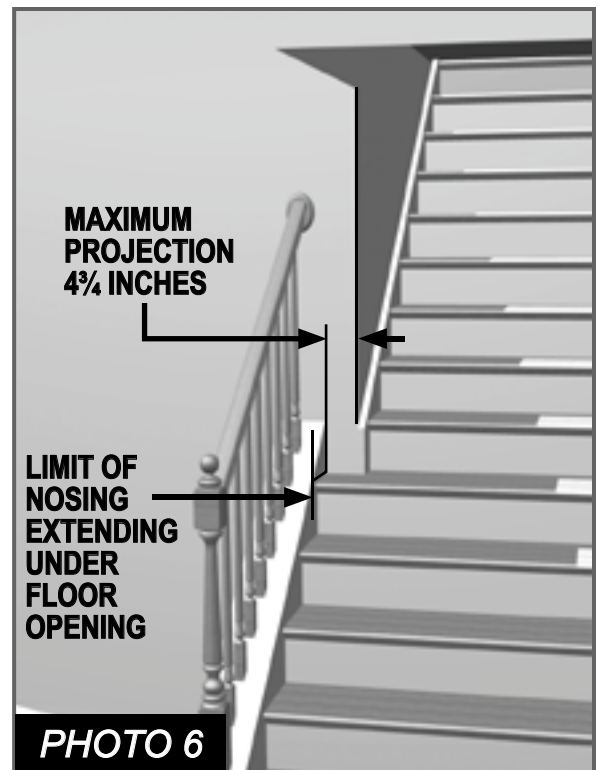
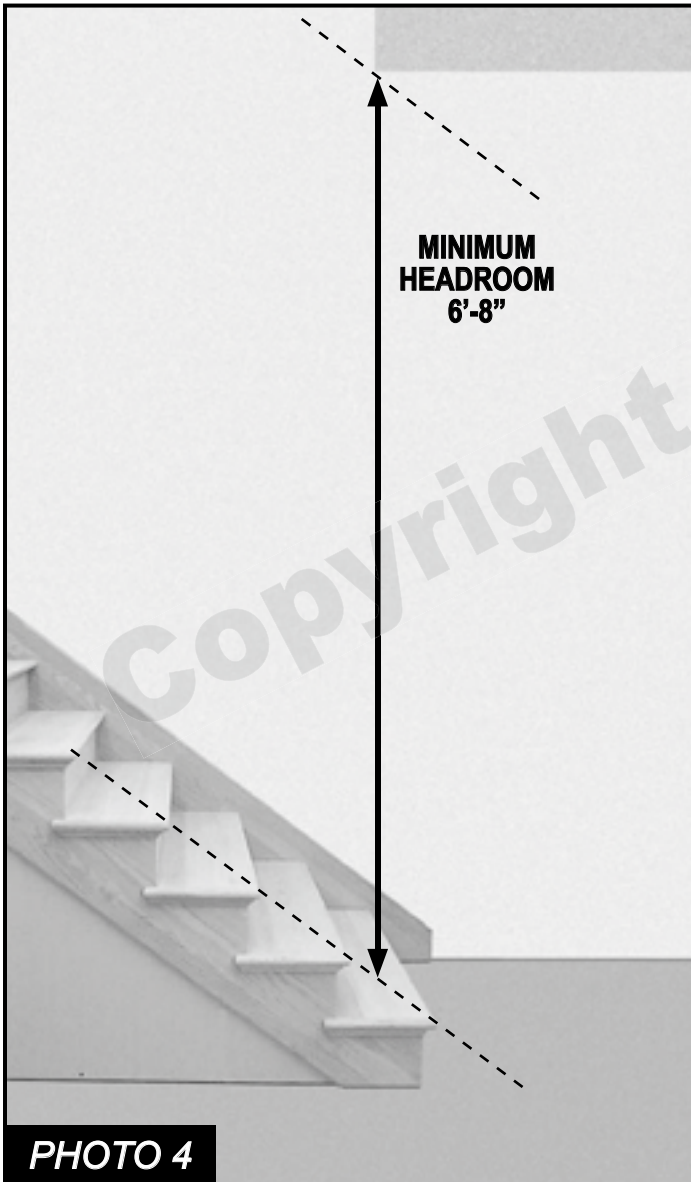
**Exception:** The width of spiral *stairways* shall be in accordance with Section R311.7.9.1. See **PHOTO 40** (page 15).



**R311.7.2 Headroom.**

The minimum headroom in all parts of the *stairway* shall not be less than 6 feet, 8 inches (2032 mm) measured vertically from the sloped line adjoining the tread *nosing* **PHOTO 4** or from the floor surface of the landing or platform on that portion of the *stairway*. **PHOTO 5**.

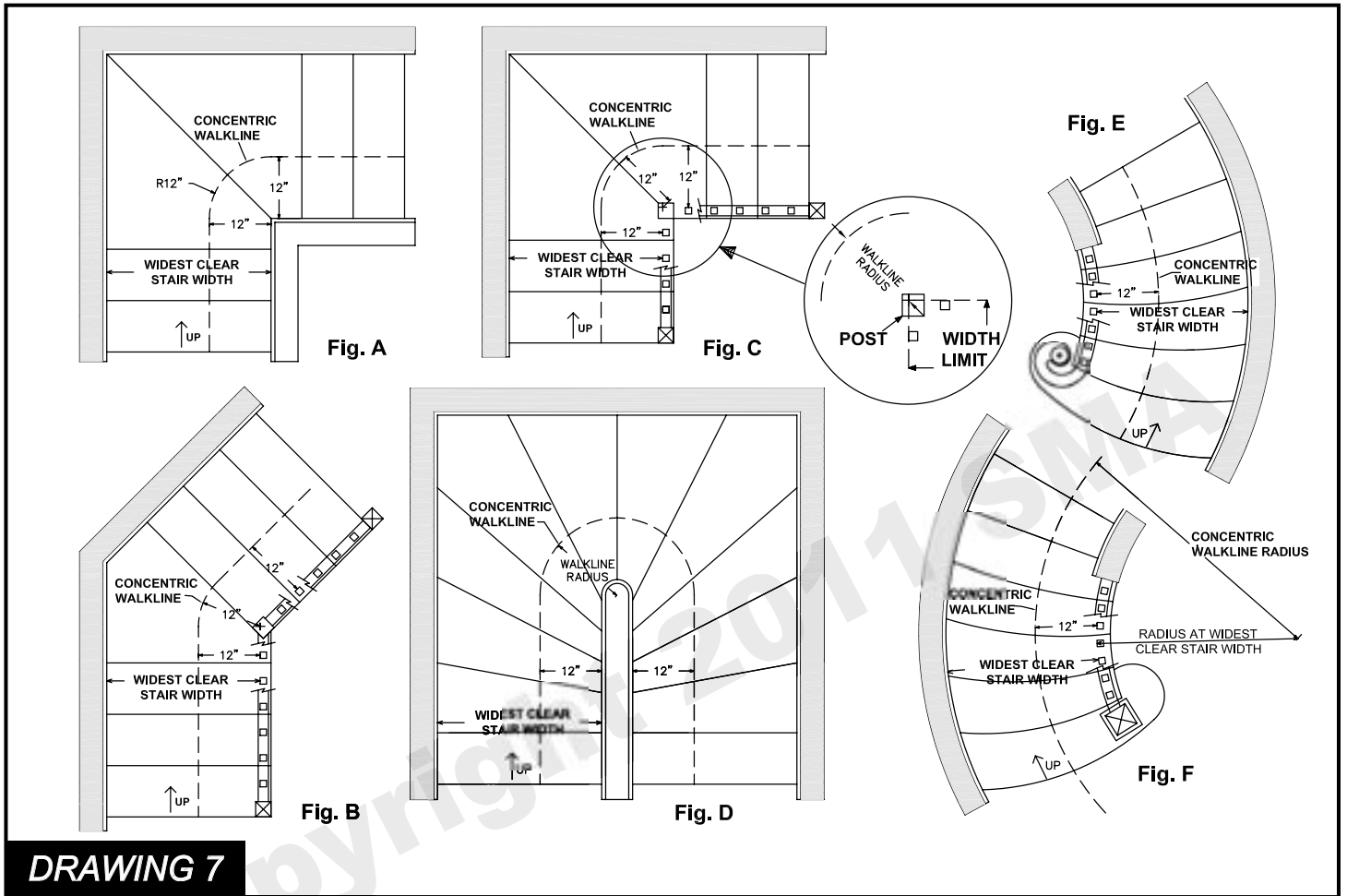
**Exception:** Where the *nosings* of treads at the side of a flight extend under the edge of a floor opening through which the stair passes, the floor opening shall be allowed to project horizontally into the required headroom a maximum of 4¾ inches (121 mm). **PHOTO 6**



**R311.7.3 Walkline.**

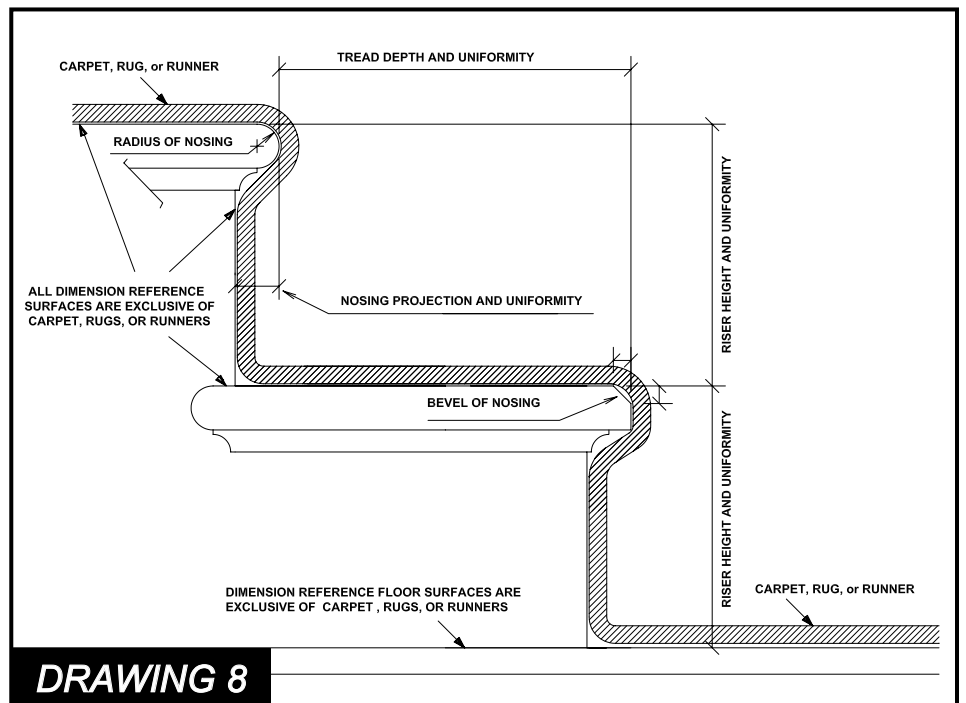
The walkline across *winder* treads shall be concentric to the curved direction of travel through the turn and located 12 inches (305 mm) from the side where the *winders* are narrower. The 12-inch (305 mm) dimension shall be measured from the widest point of the clear *stair* width at the walking surface of the *winder*.

**DRAWING 7 figures A-F.** If *winders* are adjacent within the *flight*, **DRAWING 9 (p. 6)** the point of the widest clear *stair* width of the adjacent *winders* shall be used **DRAWING 7 figures E-F.**



**R311.7.4 Stair treads and risers.**

*Stair* treads and risers shall meet the requirements of this section. For the purposes of this section all dimensions and dimensioned surfaces shall be exclusive of carpets, rugs or runners. **DRAWING 8.**



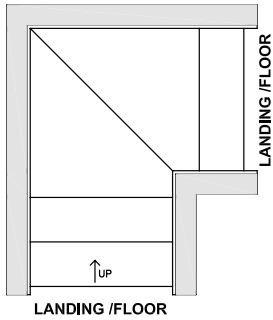


### R311.7.4.1 Riser height.

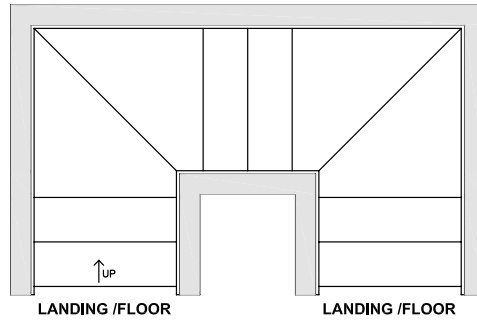
The maximum riser height shall be 7¾ inches (196 mm). The riser shall be measured vertically between leading edges of the adjacent treads. **PHOTO 10.** The greatest riser height within any *flight* **DRAWING 9** of stairs shall not exceed the smallest by more than ¾ inch (9.5 mm). **PHOTO 11.**

## ICC DEFINITION - from Chapter 2 IRC and IBC

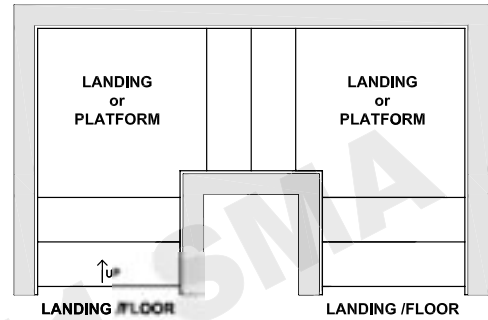
**Flight - a continuous run of rectangular treads or winders or any combination thereof from one landing to another**



**Fig A**  
**ONE FLIGHT**

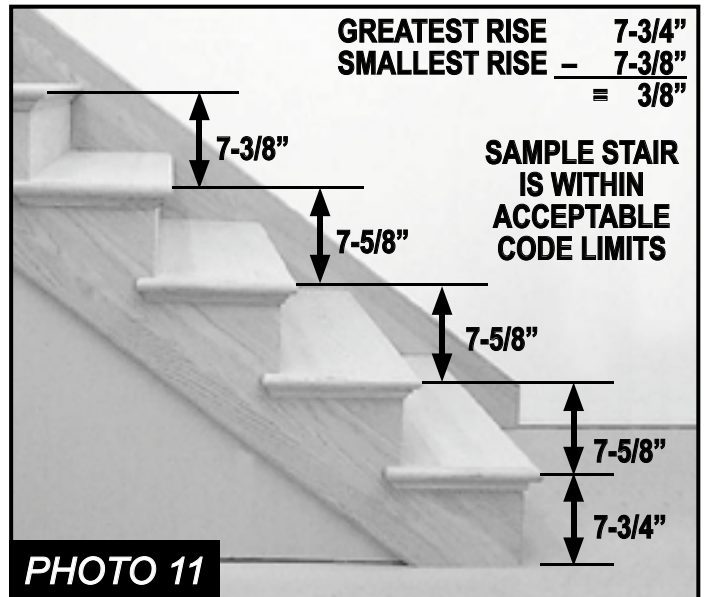
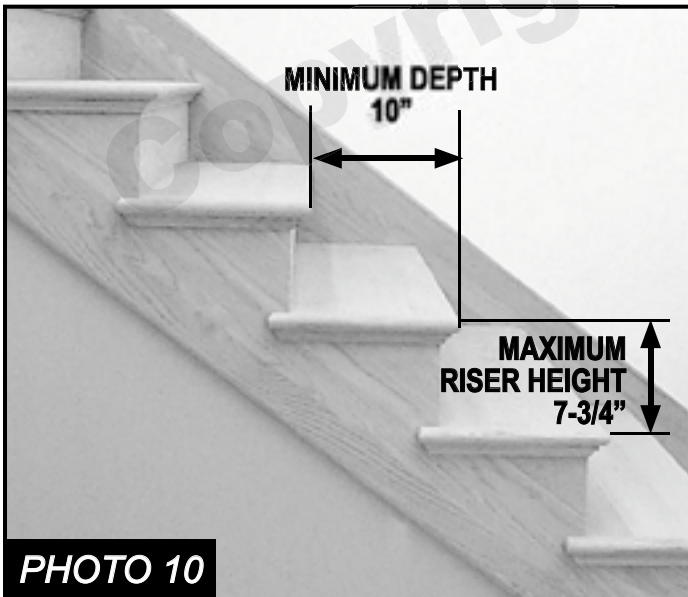


**Fig B**  
**ONE FLIGHT**



**Fig C**  
**THREE FLIGHTS**

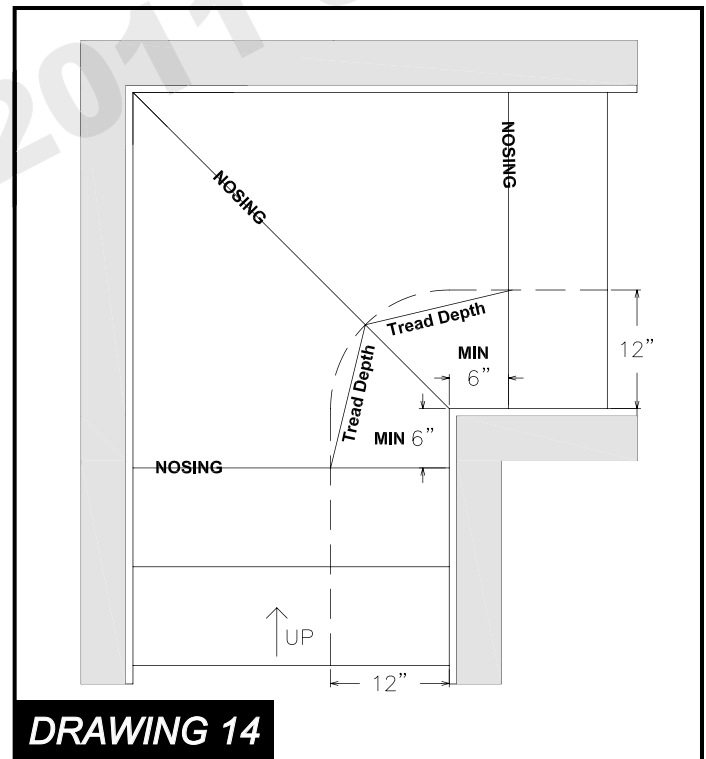
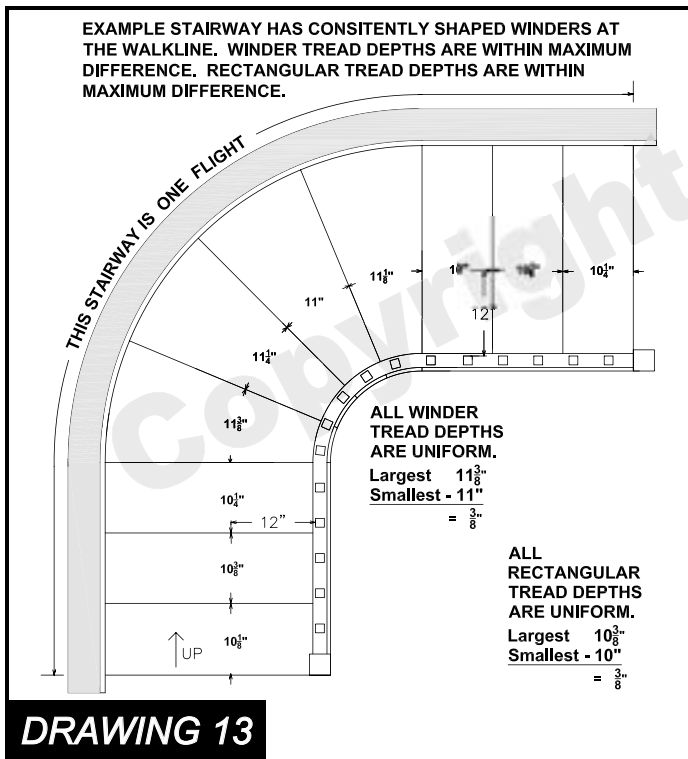
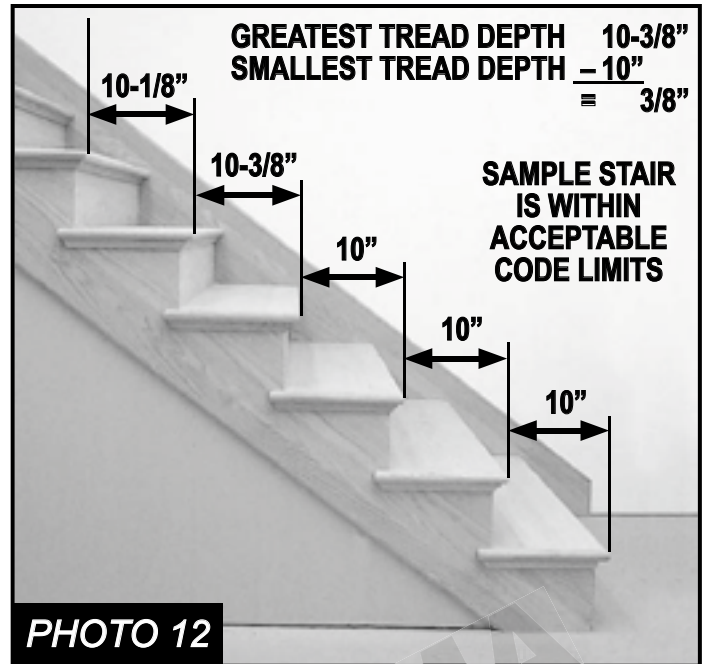
**DRAWING 9**



**R311.7.4.2 Tread depth.**

The minimum tread depth shall be 10 inches (254 mm). The tread depth shall be measured horizontally between the vertical planes of the foremost projection of adjacent treads and at a right angle to the tread's leading edge. **PHOTO 10.** The greatest tread depth within any *flight* **DRAWING 9** of stairs shall not exceed the smallest by more than 3/8 inch (9.5 mm). **PHOTO 12.** Consistently shaped *winders* at the walkline shall be allowed within the same *flight* of stairs as rectangular treads and do not have to be within 3/8 inch (9.5 mm) of the rectangular tread depth. **DRAWING 13**

*Winder* treads shall have a minimum tread depth of 10 inches (254 mm) measured between the vertical planes of the foremost projection of adjacent treads at the intersections with the walkline. *Winder* treads shall have a minimum tread depth of 6 inches (152 mm) at any point within the clear width of the *stair*. **DRAWING 14** Within any *flight* **DRAWING 9** of stairs, the largest *winder* tread depth at the walkline shall not exceed the smallest *winder* tread by more than 3/8 inch (9.5 mm). **DRAWING 13**



# ICC DEFINITION - from Chapter 2 IRC and IBC

**Winder - A tread with non-parallel edges**

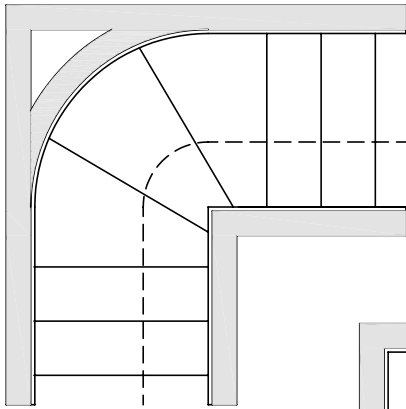


fig. A

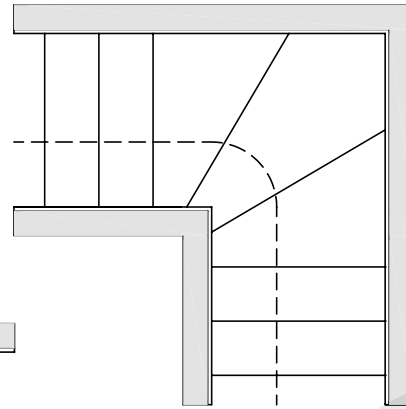


fig. B

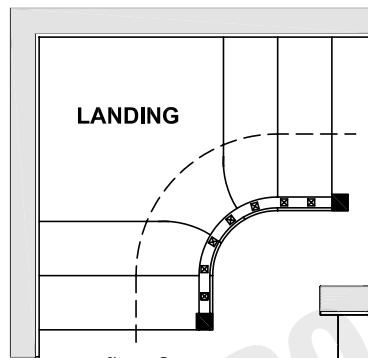


fig. C

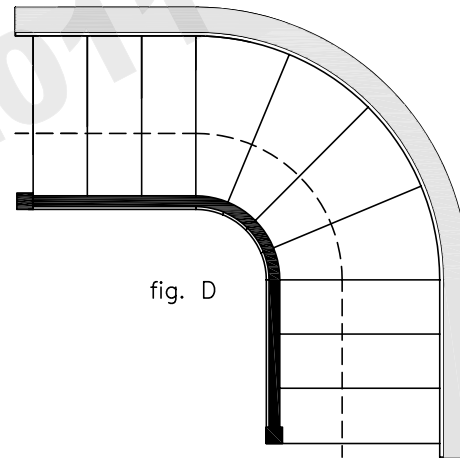


fig. D

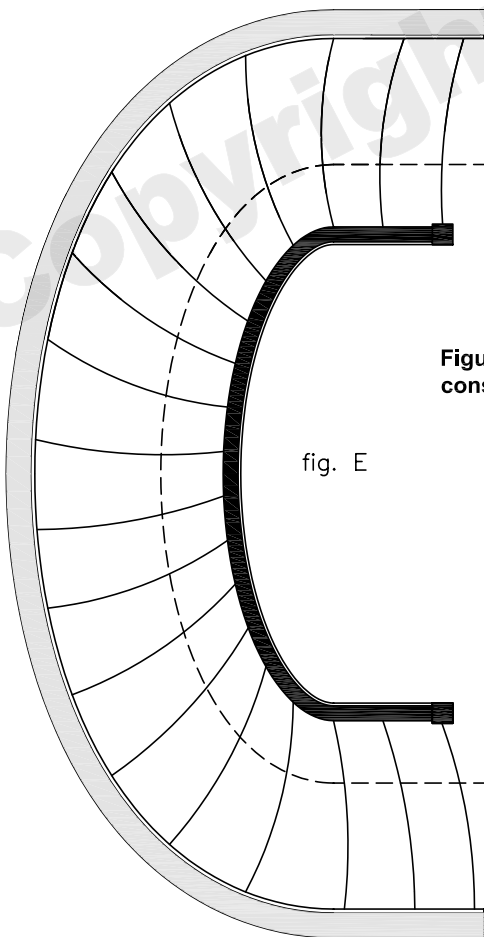


fig. E

**Figures A-F illustrate common stairway designs with consistently shaped winder treads at the walkline.**

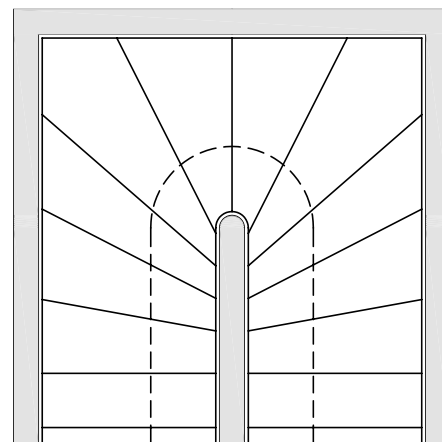


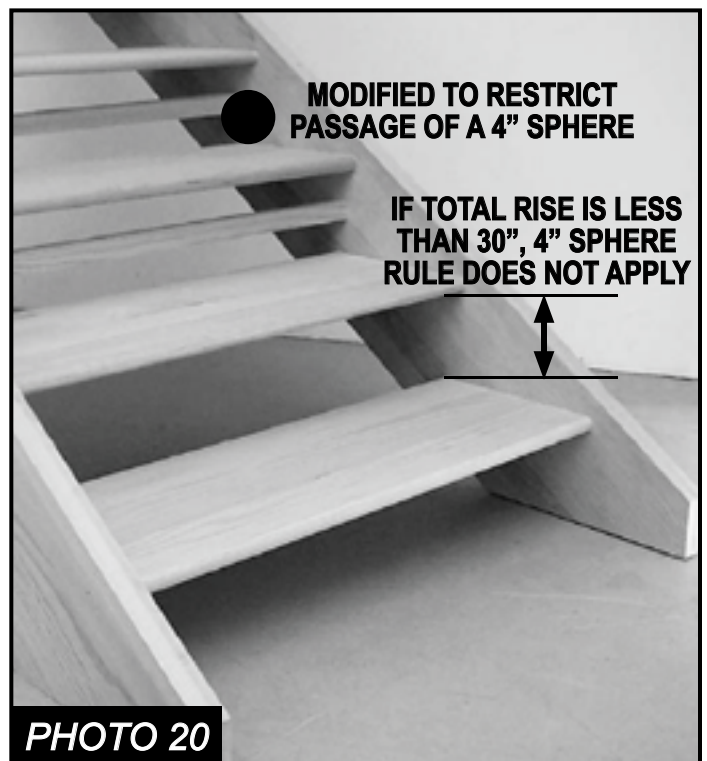
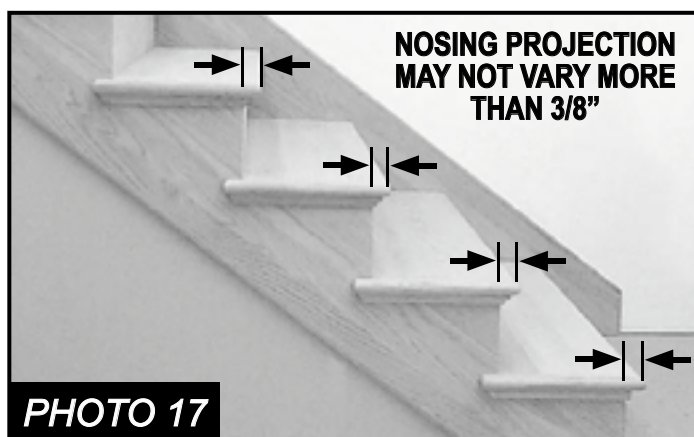
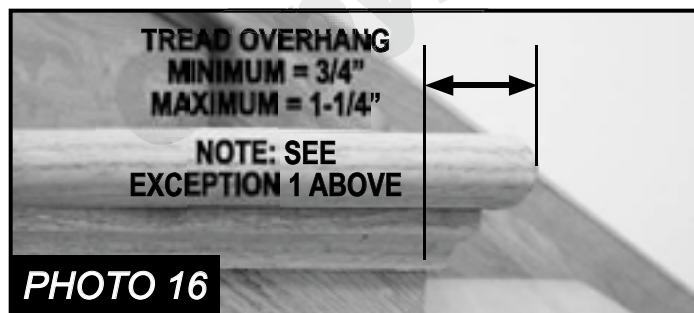
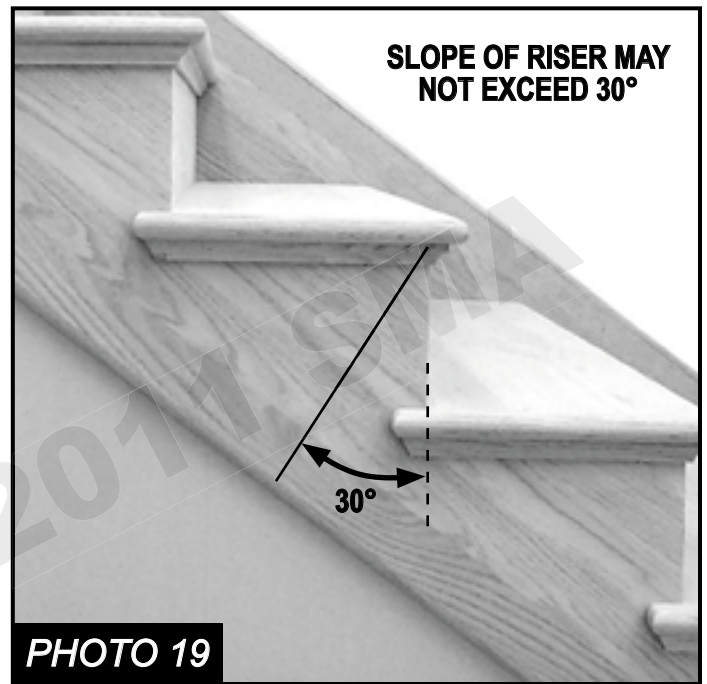
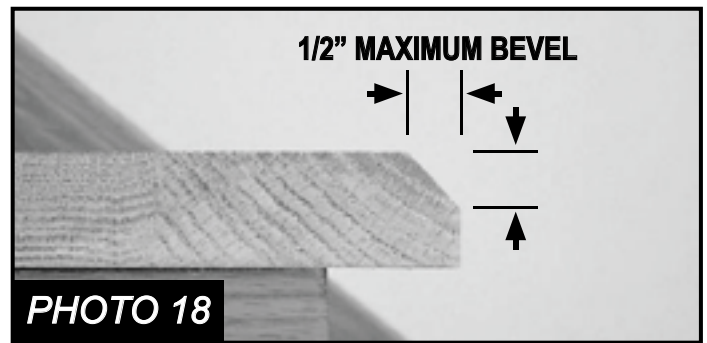
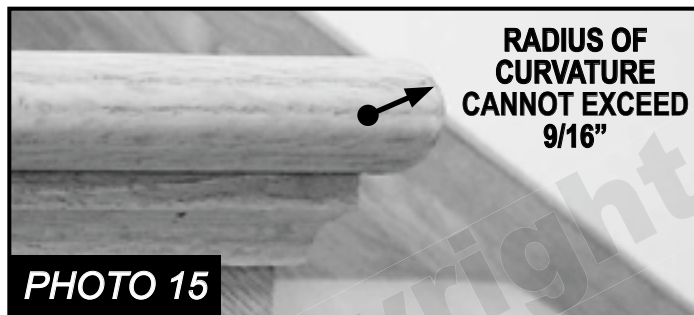
fig. F



### R311.7.4.3 Profile.

The radius of curvature at the *nosing* shall be no greater than  $\frac{9}{16}$  inch (14 mm). **PHOTO 15.** A *nosing* not less than  $\frac{3}{4}$  inch (19 mm) but not more than  $1\frac{1}{4}$  inches (32 mm) shall be provided on stairways with solid risers. **PHOTO 16.** The greatest *nosing* projection shall not exceed the smallest *nosing* projection by more than  $\frac{3}{8}$  inch (9.5 mm) between two stories, including the *nosing* at the level of floors and landings. **PHOTO 17.** Beveling of nosing shall not exceed  $\frac{1}{2}$  inch (12.7 mm). **PHOTO 18.** Risers shall be vertical or sloped under the tread above from the underside of the *nosing* above at an angle not more than 30 degrees (0.51 rad) from the vertical. **PHOTO 19.** Open risers are permitted, provided that the opening between treads does not permit the passage of a 4-inch diameter (102 mm) sphere. **PHOTO 20.**

- Exceptions:**
1. A *nosing* is not required where the tread depth is a minimum of 11 inches (279 mm).
  2. The opening between adjacent treads is not limited on *stairs* with a total rise of 30 inches (762 mm) or less. **PHOTO 20.**

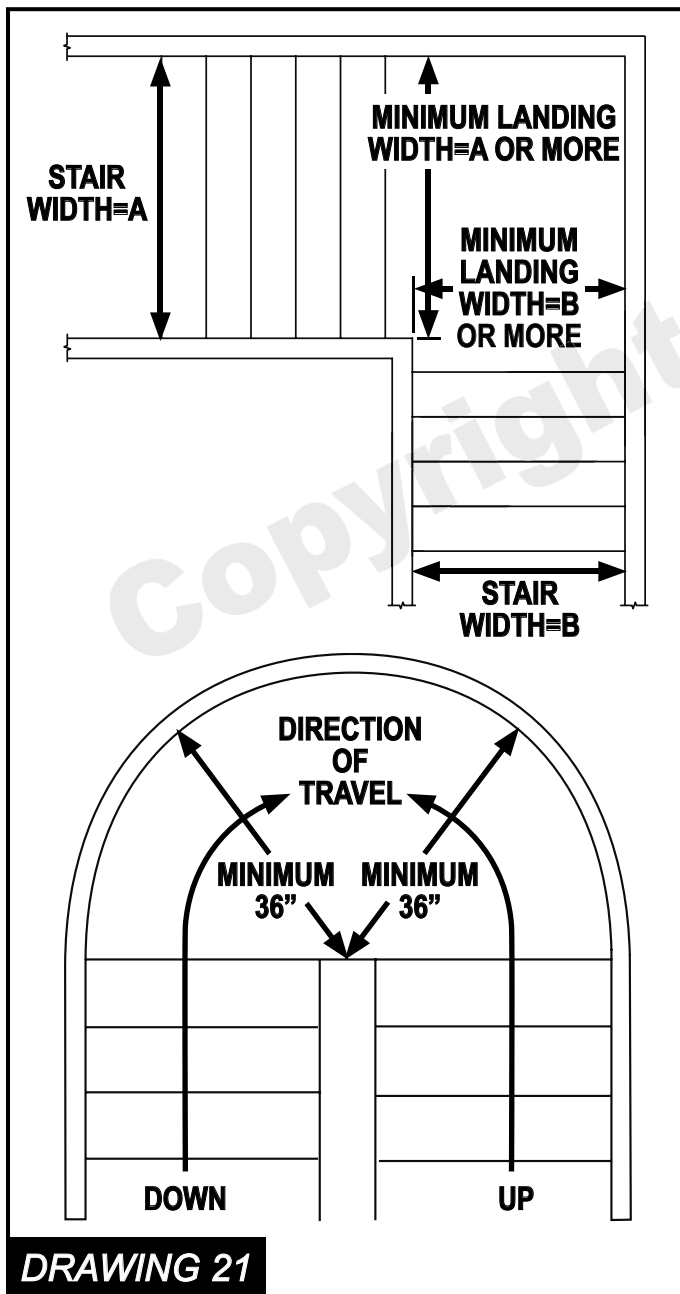


**R311.7.4.4 Exterior wood/plastic composite stair treads.** Wood/plastic composite *stair* treads shall comply with the provisions of Section R317.4.

**R311.7.5 Landings for stairways.**

There shall be a floor or landing at the top and bottom of each *stairway*.

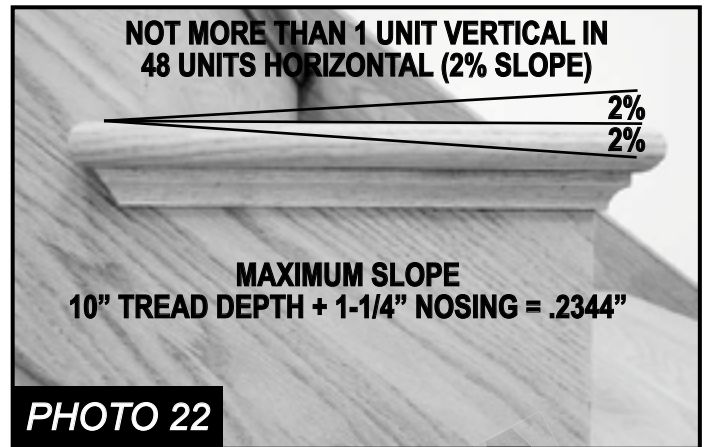
**Exception:** A floor or landing is not required at the top of an interior *flight* of *stairs*, including *stairs* in an enclosed garage, provided a door does not swing over the *stairs*. A *flight* of *stairs* shall not have a vertical rise larger than 12 feet (3658 mm) between floor levels or landings. The width of each landing shall not be less than the width of the *stairway* served. Every landing shall have a minimum dimension of 36 inches (914 mm) measured in the direction of travel. **DRAWING 21**



**R311.7.6 Stairway walking surface.**

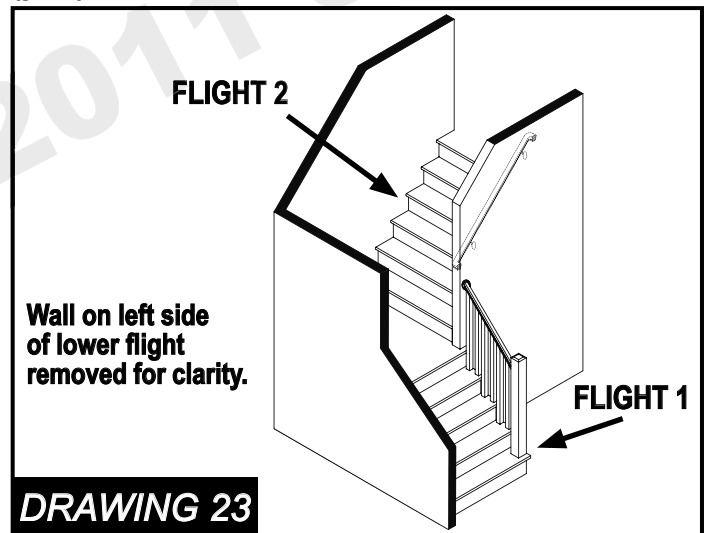
The walking surface of treads and landings of *stairways* shall be sloped no steeper than one unit vertical in 48 inches horizontal (2-percent slope).

**PHOTO 22.**



**R311.5.6 Handrails.**

*Handrails* shall be provided on at least one side of each continuous run of treads or *flight* **DRAWING 9** (p. 6) with four or more risers. **DRAWING 23.**

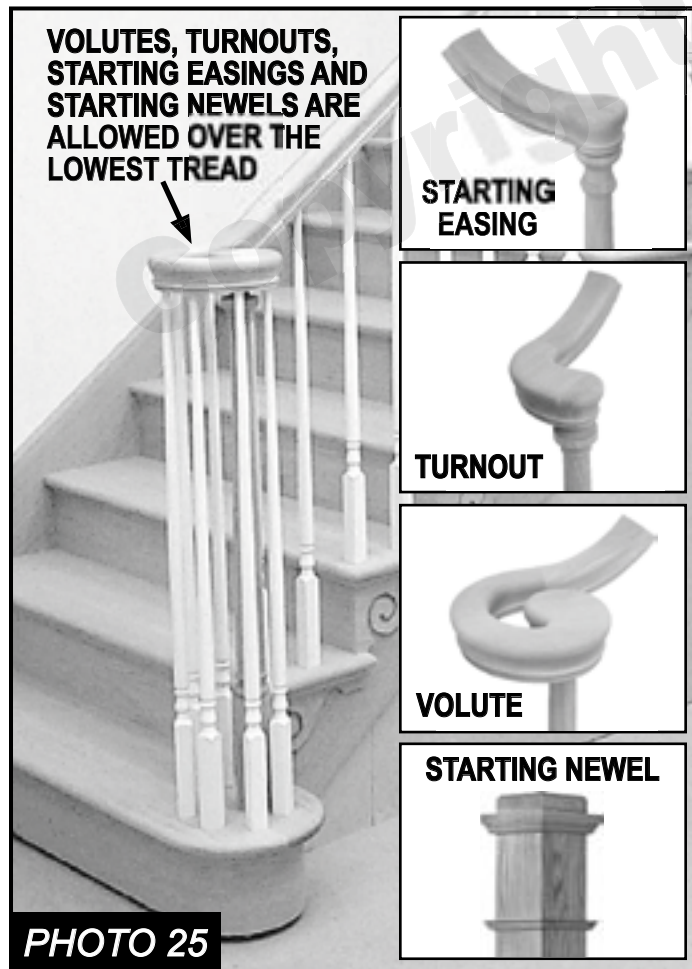
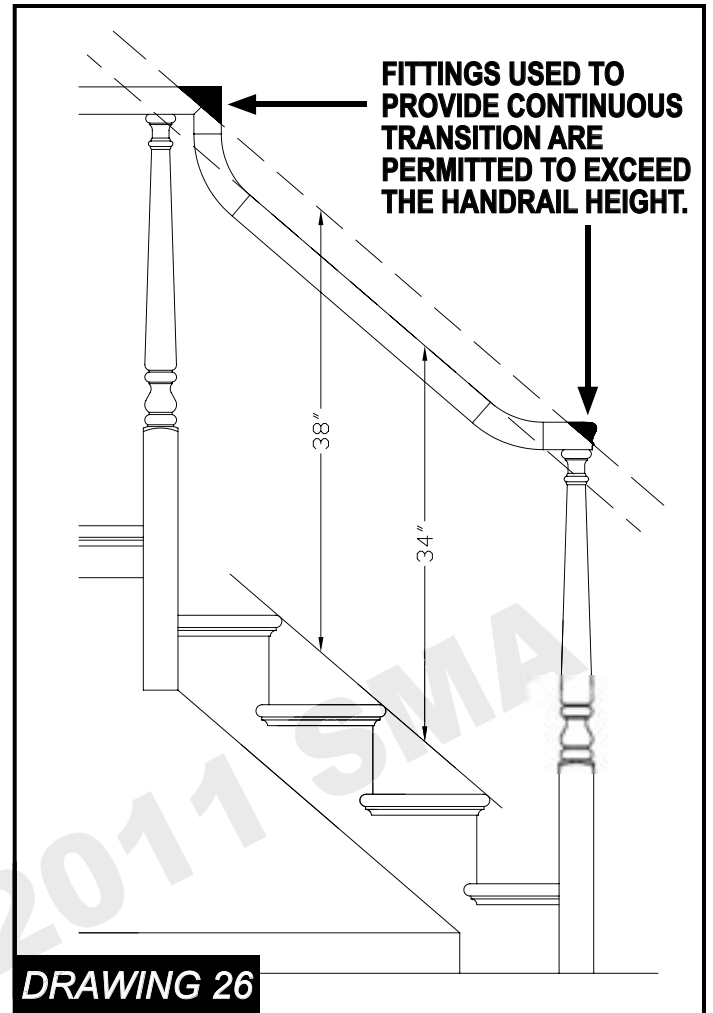


**R311.7.7.1 Height.** *Handrail* height, measured vertically from the sloped plane adjoining the tread *nosing*, or finish surface of ramp slope, shall be not less than 34 inches (864 mm) and not more than 38 inches (965 mm). **PHOTO 24.**

**Exceptions:**

1. The use of a volute, turnout or starting easing shall be allowed over the lowest tread. **PHOTO 25**

2. When *handrail* fittings or bendings are used to provide continuous transition between *flights*, the transition from *handrail* to guardrail, or used at the start of a *flight*, the *handrail* height at the fittings or bendings shall be permitted to exceed the maximum height. **DRAWING 26**



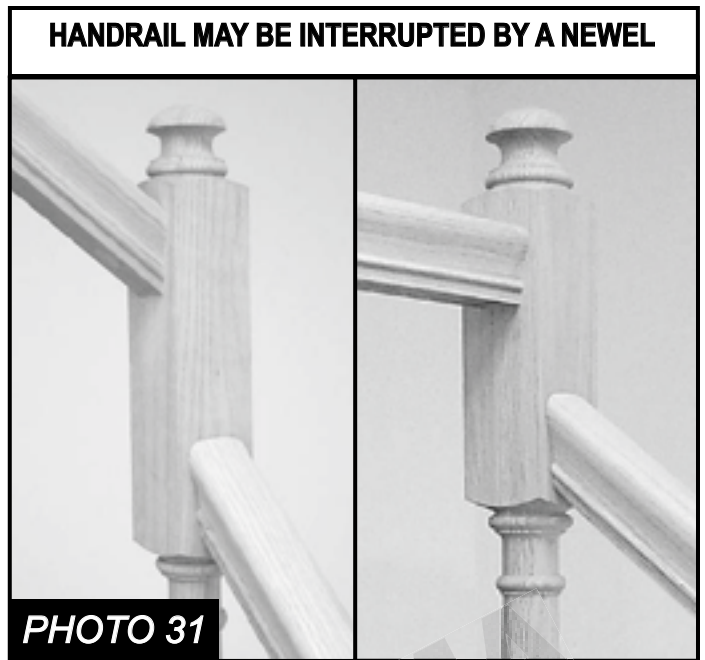
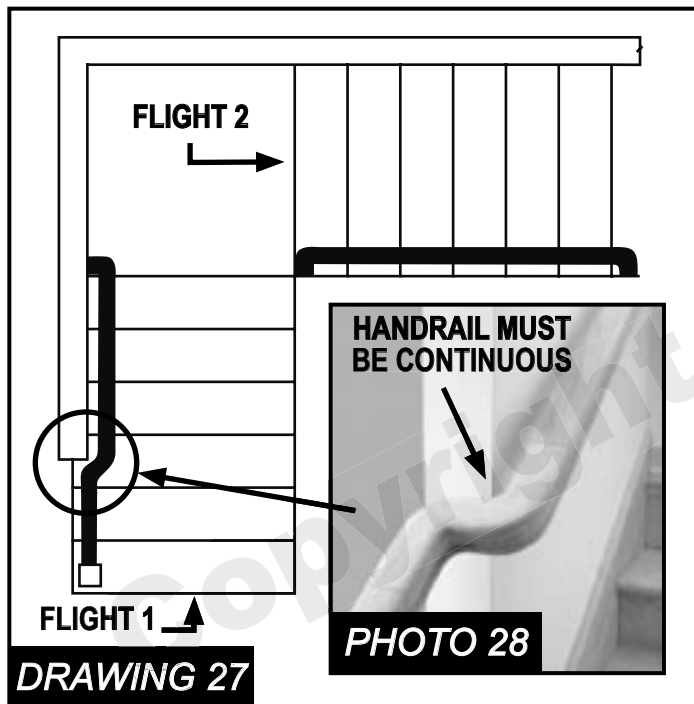
**R311.7.7.2 Continuity.**

*Handrails* for stairways shall be continuous for the full length of the *flight*, **DRAWING 26 (p. 11)** from a point directly above the top riser of the *flight* to a point directly above the lowest riser of the *flight*.

**DRAWING 27** and **PHOTO 28** *Handrail* ends shall be returned **PHOTO 29** or shall terminate in newel posts or safety terminals. *Handrails* adjacent to a wall shall have a space of not less than 1½ inch (38 mm) between the wall and the *handrails*. **PHOTO 30**

**Exceptions:** 1. *Handrails* shall be permitted to be interrupted by a newel post at the turn. **PHOTO 31**

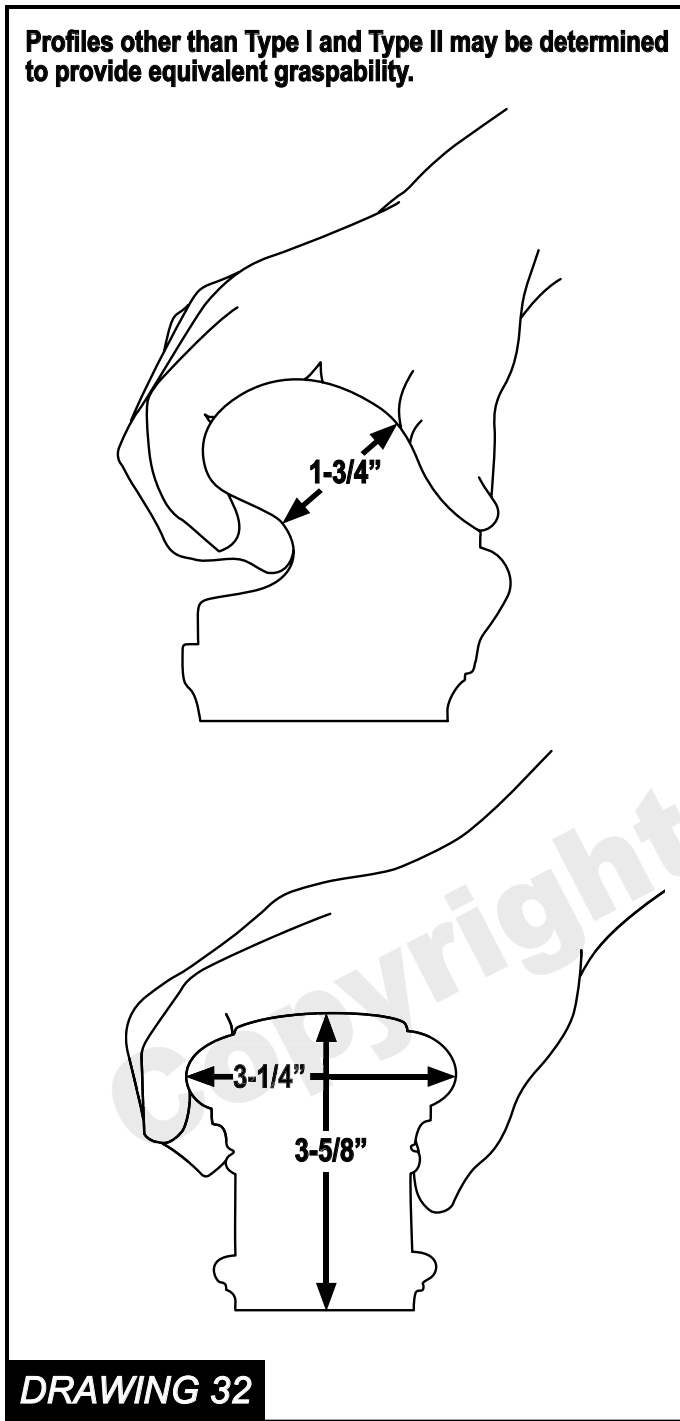
2. The use of a volute, turnout, starting easing or starting newel shall be allowed over the lowest tread. **PHOTO 25 (p. 11)**





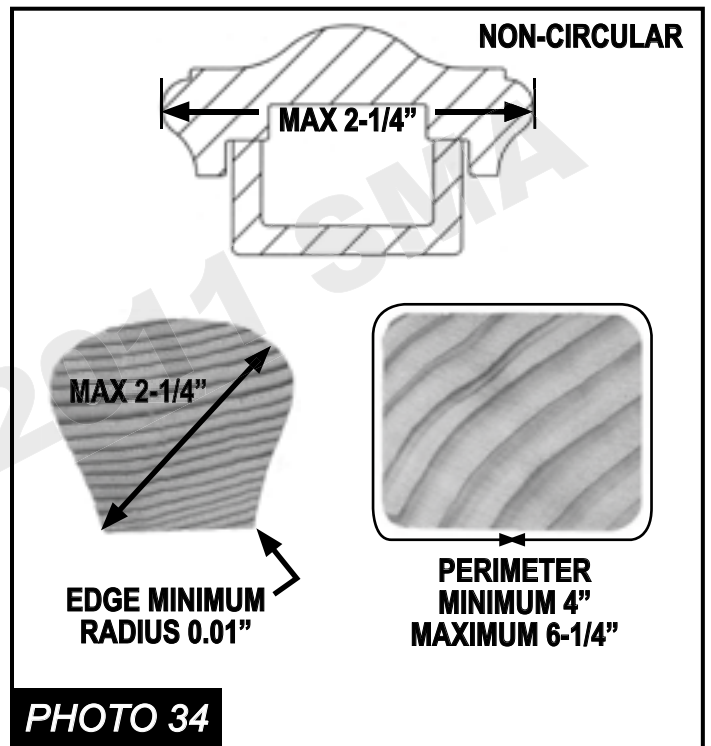
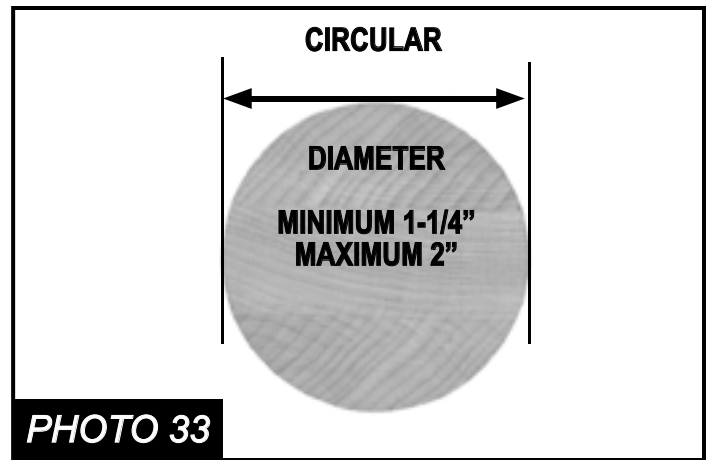
**R311.7.7.3 Grip-size.**

All required *handrails* shall be of one of the following types or provide equivalent graspability. **DRAWING 32.**

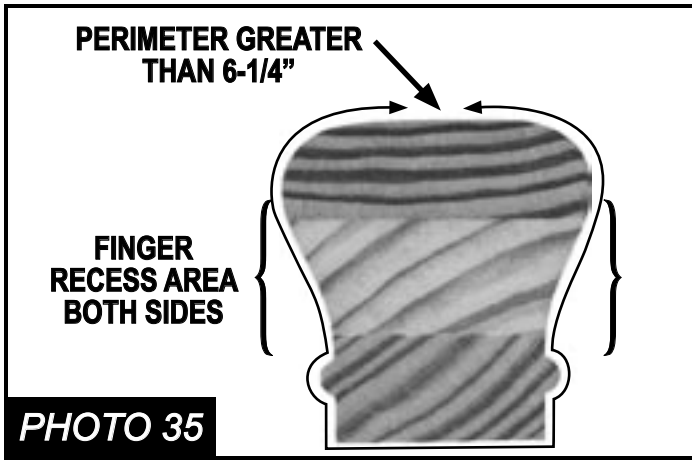


1. Type I. *Handrails* with a circular cross section shall have an outside diameter of at least 1 1/4 inches (32 mm) and not greater than 2 inches (51 mm).

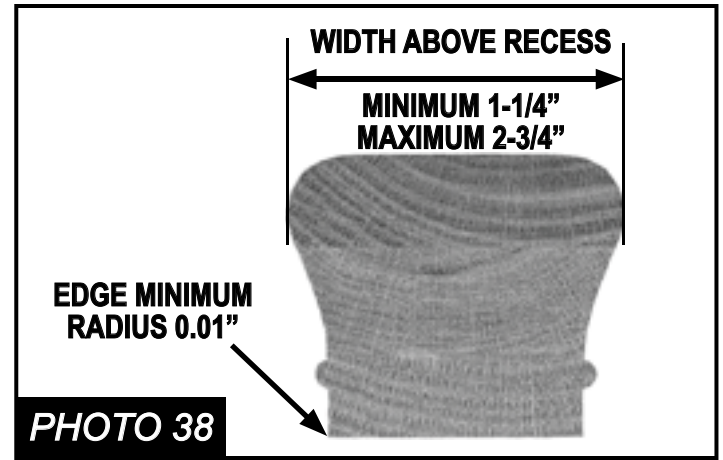
**PHOTO 33.** If the *handrail* is not circular, it shall have a perimeter dimension of at least 4 inches (102 mm) and not greater than 6 1/4 inches (160 mm) with a maximum cross section of dimension of 2 1/4 inches (57 mm). Edges shall have a minimum radius of 0.01 inches (0.25 mm) **PHOTO 34.**



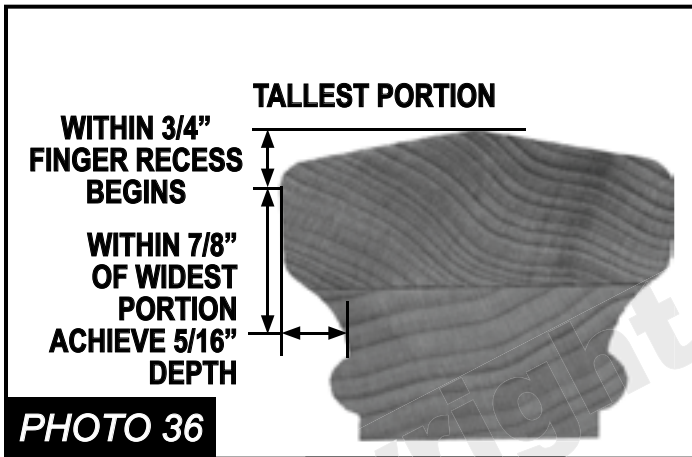
2. Type II. *Handrails* with a perimeter greater than 6 1/4 inches (160mm) shall provide a graspable finger recess area on both sides of the profile. The finger recess shall begin within a distance of 3/4 inch (19 mm) measured vertically from the tallest portion of the profile and achieve a depth of at least 5/16 inch (8mm) within 7/8 inch (22mm) below the widest portion of the profile. This required depth shall continue for at least 3/8 inch (10mm) to a level that is not less than 1 3/4 inches (45 mm) below the tallest portion of the profile. The minimum width of the handrail above the recess shall be 1 1/4 inches (32 mm) to a maximum of 2 3/4 inches (70 mm). Edges shall have a minimum radius of 0.01 inches (0.25 mm). **SEE ILLUSTRATIONS NEXT PAGE**



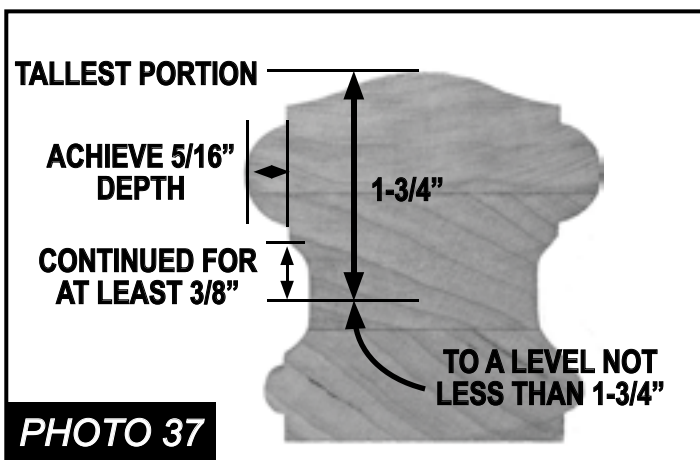
Handrails with a perimeter greater than 6¼ inches (160mm) shall provide a graspable finger recess area on both sides of the profile. **PHOTO 35.**



The minimum width of the handrail above the recess shall be 1¼ inches (32 mm) to a maximum of 2¾ inches (70 mm). **PHOTO 38.** Edges shall have a minimum radius of 0.01 inches (0.25 mm). **PHOTO 38.**



The finger recess shall begin within a distance of ¾ inch (19 mm) measured vertically from the tallest portion of the profile and achieve a depth of at least 5/16 inch (8mm) within 7/8 inch (22mm) below the widest portion of the profile. **PHOTO 36.**



This required depth shall continue for at least 3/8 inch (10mm) to a level that is not less than 1¾ inches (45 mm) below the tallest portion of the profile. **PHOTO 37.**

**R311.7.7.4 Exterior wood/plastic composite handrails.** Wood/plastic composite *handrails* shall comply with the provisions of Section R317.4.

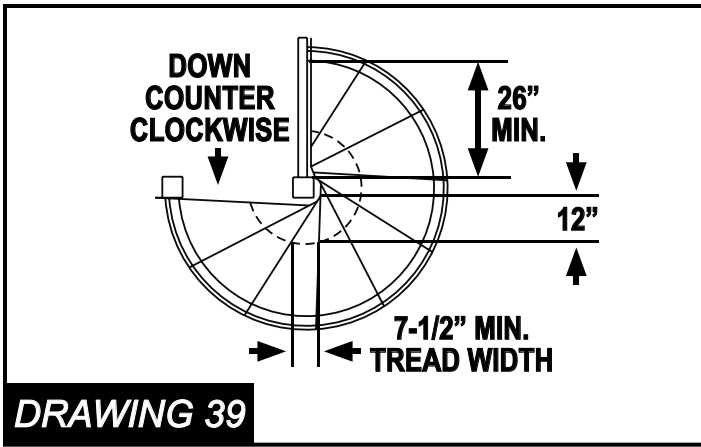
**R311.7.8 Illumination.**

All *stairs* shall be provided with illumination in accordance with Section R303.6.

**R311.7.9 Special stairways.** Spiral *stairways* and bulkhead enclosure *stairways* shall comply with all requirements of Section R311.7 except as specified below.

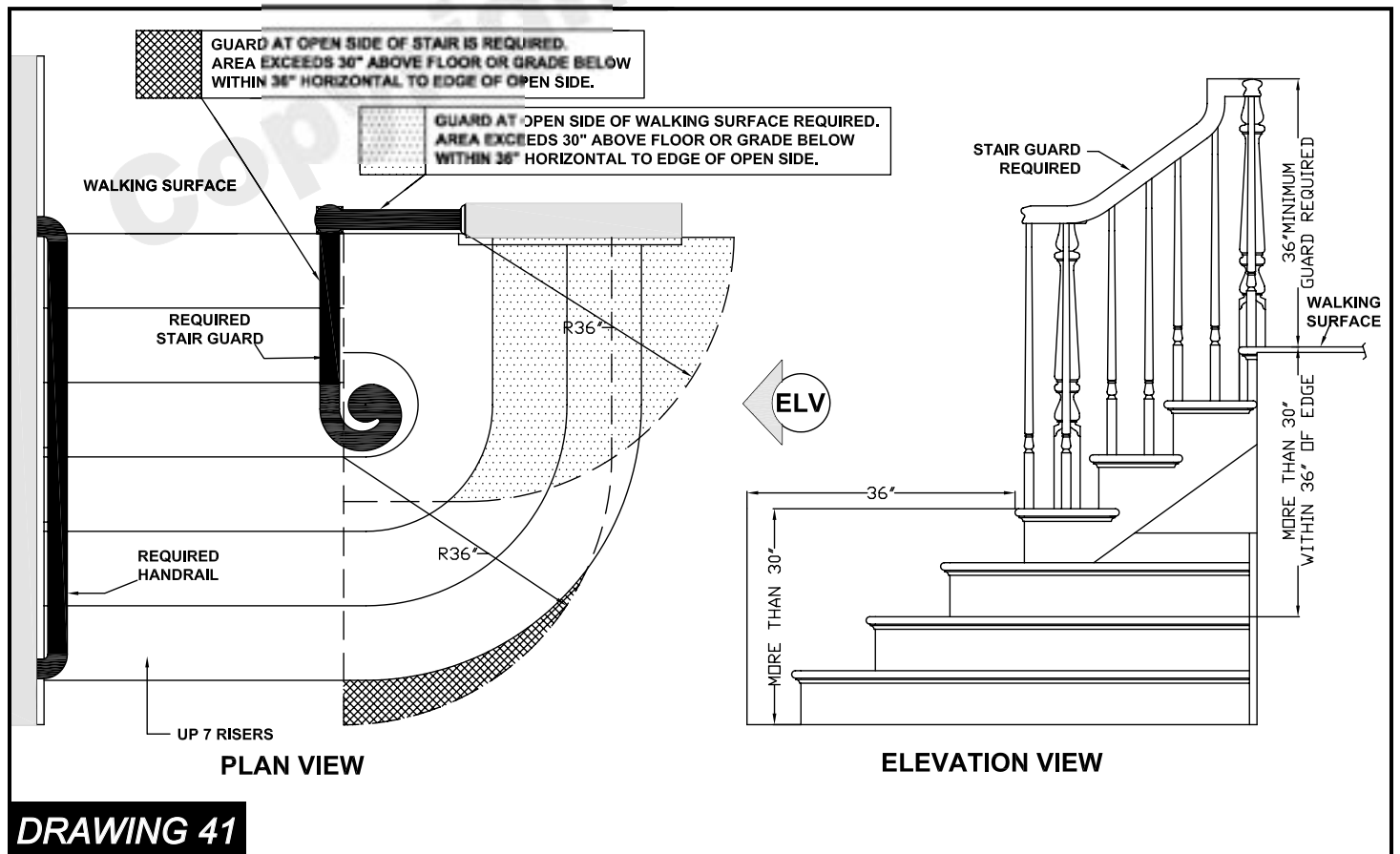
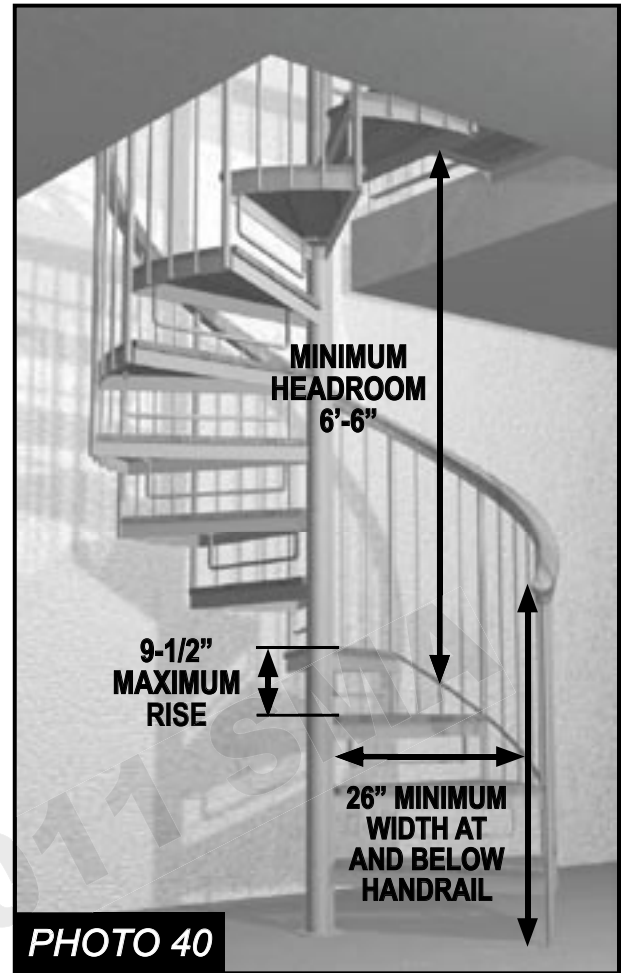
**R311.7.9.1 Spiral stairways.** Spiral *stairways* are permitted, provided the minimum clear width at and below the *handrail* shall be 26 inches (660 mm) **DRAWING 39 & PHOTO 40** with each tread having a 7½-inch (190 mm) minimum tread depth at 12 inches (914 mm) from the narrower edge. All treads shall be identical, **DRAWING 39** and the rise shall be no more than 9½ inches (241 mm). A minimum headroom of 6 feet 6 inches (1982 mm) shall be provided. **PHOTO 40**





**R311.7.9.2 Bulkhead enclosure stairways.**

Stairways serving bulkhead enclosures, not part of the required building egress, providing access from the outside *grade* level to the *basement* shall be exempt from the requirements of Sections R311.3 and R311.7 where the maximum height from the *basement* finished floor level to *grade* adjacent to the *stairway* does not exceed 8 feet (2438 mm) and the *grade* level opening to the *stairway* is covered by a bulkhead enclosure with hinged doors or other *approved* means.



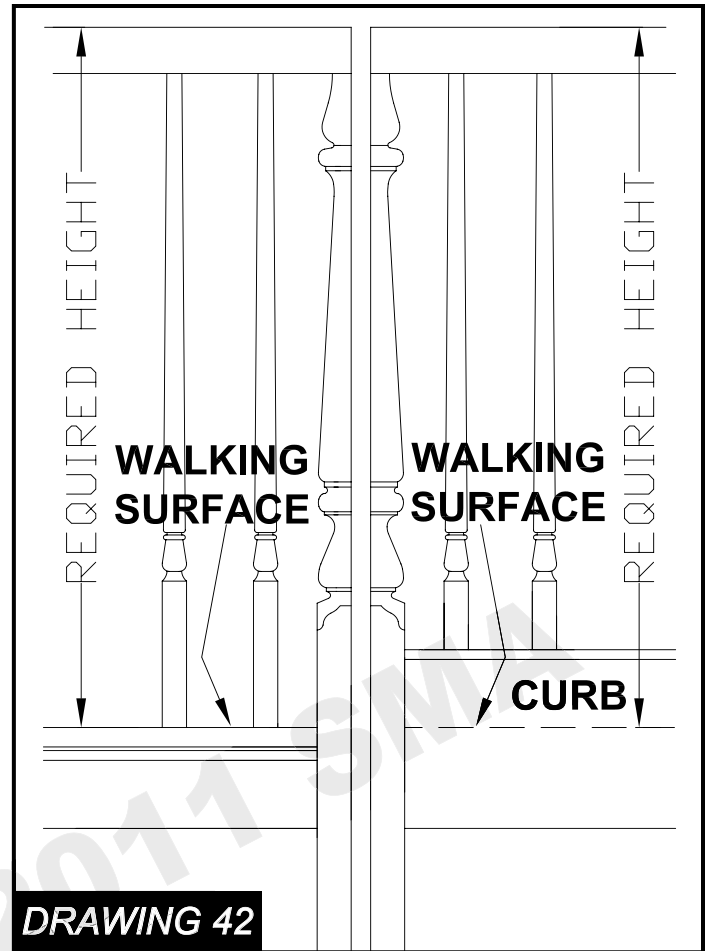
## SECTION R312 GUARDS

**R312.1 Where required.** *Guards* shall be located along open-sided walking surfaces, including *stairs*, ramps and landings, that are located more than 30 inches (762 mm) measured vertically to the floor or *grade* below at any point within 36 inches (914 mm) horizontally to the edge of the open side. **DRAWING 41 (P. 15)** Insect screening shall not be considered as a *guard*.

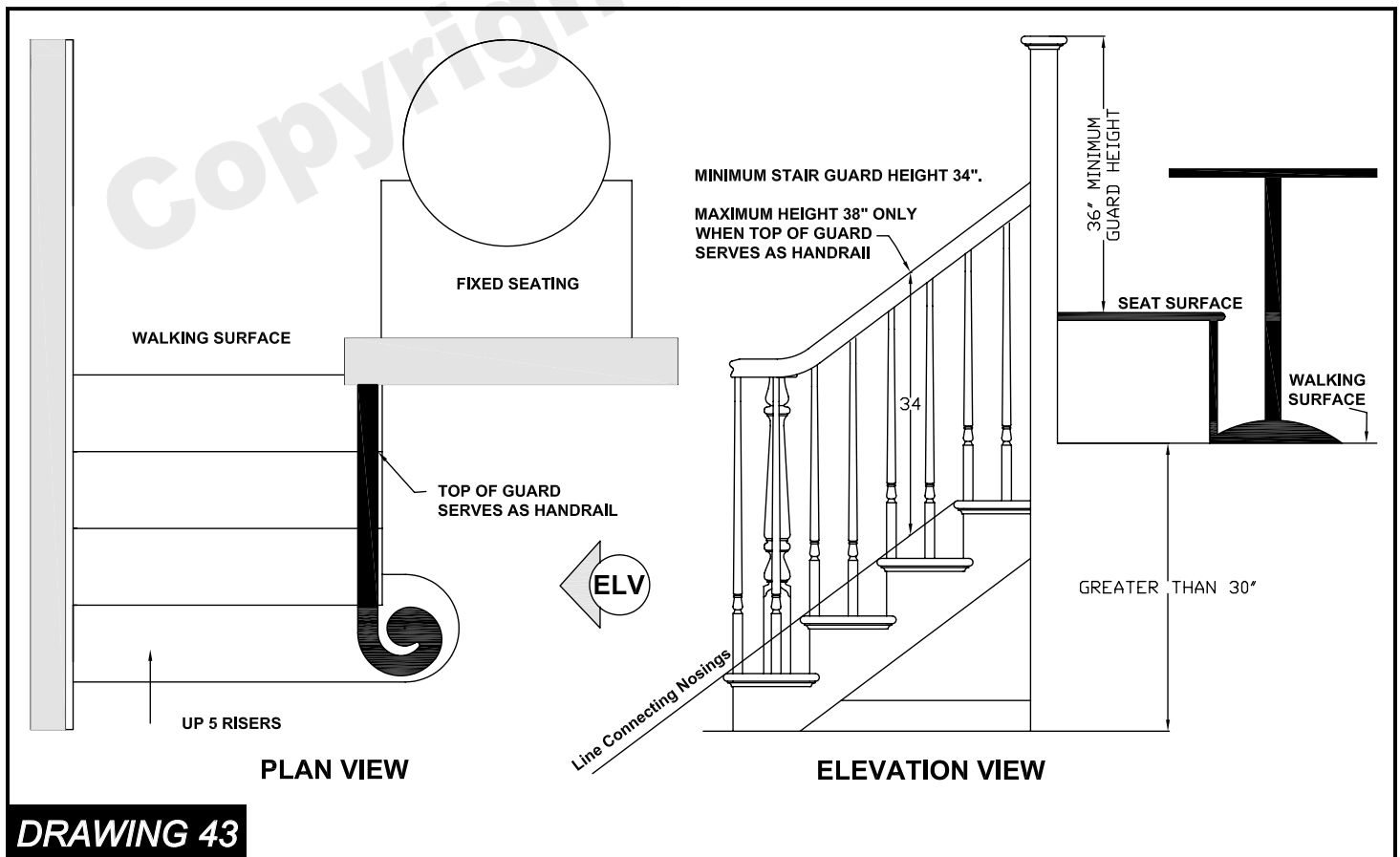
**R312.2 Height.** Required *guards* at open-sided walking surfaces, including *stairs*, porches, balconies or landings, shall be not less than 36 inches (914 mm) high measured vertically above the adjacent walking surface, **DRAWING 42** adjacent fixed seating or the line connecting the leading edges of the treads. **DRAWING 43**

**Exceptions:** 1. *Guards* on the open sides of *stairs* shall have a height not less than 34 inches (864 mm) measured vertically from a line connecting the leading edges of the treads. **DRAWING 43**

2. Where the top of the *guard* also serves as a *handrail* on the open sides of *stairs*, the top of the *guard* shall not be not less than 34 inches (864 mm) and not more than 38 inches (965 mm) measured vertically from a line connecting the leading edges of the treads. **DRAWING 43**



**DRAWING 42**



**DRAWING 43**

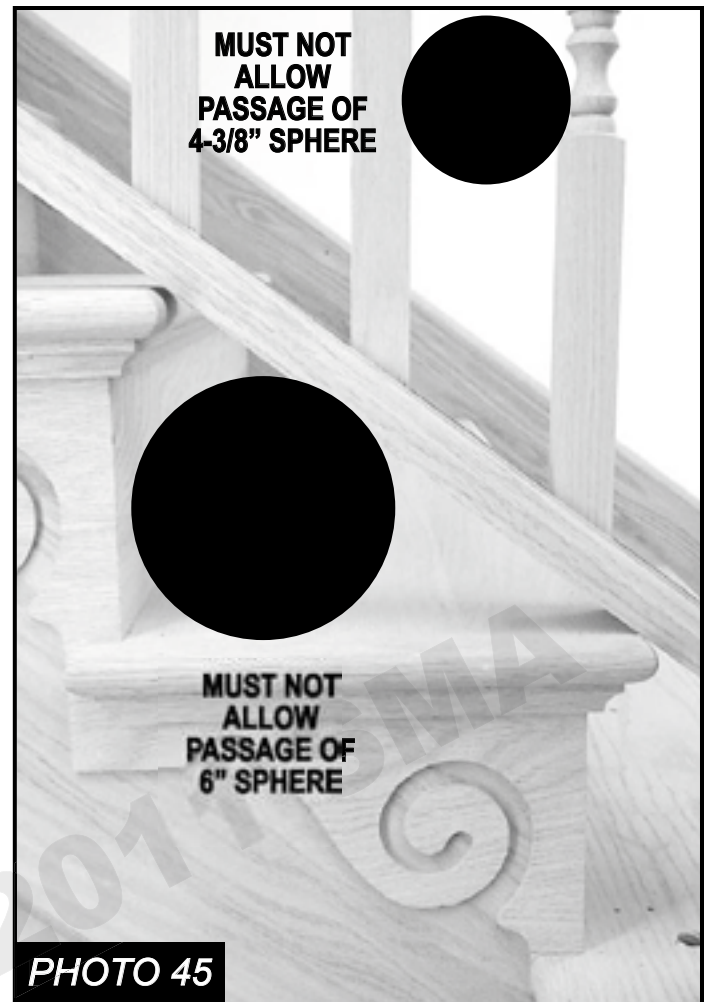
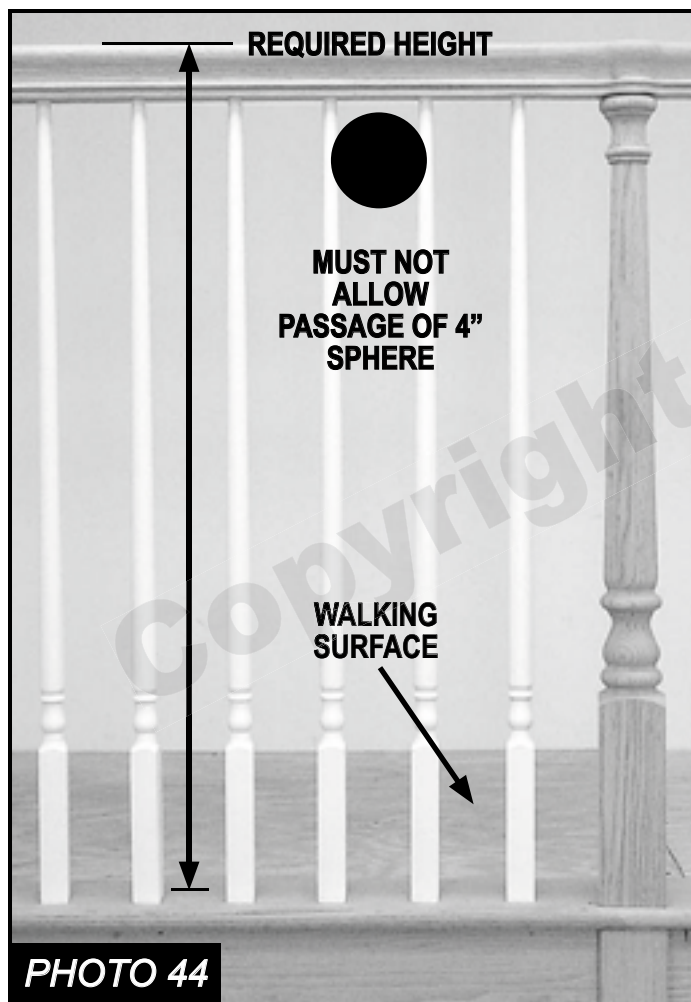
### R312.3 Opening limitations.

Required *guards* shall not have openings from the walking surface to the required *guard* height which allow passage of a sphere 4 inches (102 mm).

**PHOTO 44.**

**Exception:** 1. The triangular openings at the open side of a stair, formed by the riser, tread and bottom rail of a *guard*, shall not allow passage of a sphere 6 inches (153 mm) in diameter. **PHOTO 45.**

2. *Guards* on the open sides of stairs shall not have openings which allow passage of a sphere 4<sup>3</sup>/<sub>8</sub> inches (111 mm) in diameter. **PHOTO 45.**



**R312.4 Exterior woodplastic composite guards.**  
Woodplastic composite *guards* shall comply with the provisions of Section R317.4.

## CHAPTER 2

# DEFINITIONS

**R201.3 Terms Defined in other codes.** Where terms are not defined in this code such terms shall have meanings ascribed to them as in other code publications of the International Code Council.

*Note: In order to assure a complete understanding in accordance with above we have listed all the stair related definitions from both the IRC and the IBC (International Building Code). These defined terms appear in italics within the document.*

### IRC - Section R202 Definitions

**FLIGHT.** A continuous run of rectangular treads or winders or combination thereof from one landing to another.

**GUARD.** A building component or a system of building components located near the open sides of elevated walking surfaces that minimizes the possibility of a fall from the walking surface to a lower level.

**HANDRAIL.** A horizontal or sloping rail intended for grasping by the hand for guidance or support.

**NOSING.** The leading edge of treads of stairs and of landings at the top of stairway flights.

**WINDER.** A tread with nonparallel edges.

**STAIRWAY.** One or more flights of stairs, either interior or exterior, with the necessary landings and platforms connecting them to form a continuous and uninterrupted passage from one level to another within or attached to a building, porch or deck.

### IBC - Section 1002 Definitions

**1002.1 Definitions.** The following words and terms shall, for the purposes of this chapter and as used elsewhere in this code, have the meanings shown herein.

**ALTERNATING TREAD DEVICE.** A device that has a series of steps between 50 and 70 degrees (0.87 and 1.22 rad) from horizontal, usually attached to a center support rail in an alternating manner so that the user does not have both feet on the same level at the same time.

**FLIGHT.** A continuous run of rectangular treads, winders or combination thereof from one landing to another.

**GUARD.** A building component or a system of building components located at or near the open sides of elevated walking surfaces that minimizes the possibility of a fall from the walking surface to a lower level.

**HANDRAIL.** A horizontal or sloping rail intended for grasping by the hand for guidance or support.

**NOSING.** The leading edge of treads of stairs and of landings at the top of stairway flights.

**SCISSOR STAIR.** Two interlocking stairways providing two separate paths of egress located within one stairwell enclosure.

**STAIR.** A change in elevation, consisting of one or more risers.

**STAIRWAY.** One or more flights of stairs, either exterior or interior, with the necessary landings and platforms connecting them, to form a continuous and uninterrupted passage from one level to another.

**STAIRWAY, EXTERIOR.** A stairway that is open on at least one side, except for required structural columns, beams, handrails and guards. The adjoining open areas shall be either yards, courts or public ways. The other sides of the exterior stairway need not be open.

**STAIRWAY, INTERIOR.** A stairway not meeting the definition of an exterior stairway.

**STAIRWAY, SPIRAL.** A stairway having a closed circular form in its plan view with uniform section-shaped treads attached to and radiating from a minimum-diameter supporting column.

**WINDER.** A tread with nonparallel edges.

# NOTES:




---

---

---

---

---

---

---

---

---

---

---

---

---

---

---

---

---

---

---

---

---

---

---

---

cut on line and laminate for handy field/desk reference tool

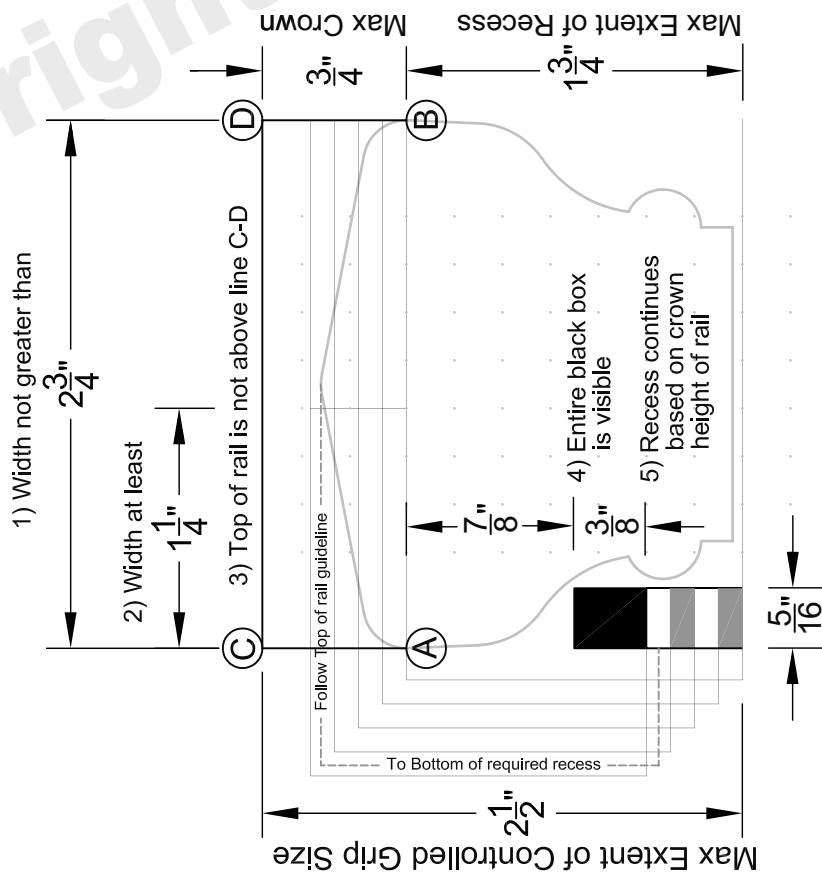


## FULL SCALE TYPE II RAIL TEST

### Instructions:

Position rail section with widest point of grip at line AB and left edge touching line AC. Keeping horizontal axis of rail parallel to line AB.

With the rail in position, it must pass tests 1) thru 5) to meet the R315.2 Type II Handrail Grip Size requirements. If profile is asymmetrical both sides must pass.



*Reproduction check: solid line measures 2.75 in.*

## THE MISSION OF THE SMA IS:

---

- To organize the varied elements of the stair industry into a leader in the code change process by actively participating at all levels.
- To write standards that insure design and installation criteria meet or exceed the minimum standard set forth by the existing code.
- To participate in design and product testing as to learn more about stair dynamics so that safety and aesthetics can coexist while incidences of stair accidents are reduced.
- To establish a central source that will disseminate to the membership current and proposed code information impacting all facets of stair building and millwork usage.
- To protect the rights and interests of both the consumer and the stair industry.

The Stairway Manufacturers' Association is dedicated to the prospect that safety and aesthetics, with respect to stairs, are not mutually exclusive.

The SMA is a broad based industry association founded in 1988. Our members include stair

parts manufacturers, stair builders, installers, millwork distributors, dealers and interested building products professionals. We are an industry organization run by industry people. Our primary focus is to represent the millwork industry to the building development groups at the local, country, state and national levels. Because the SMA represents the people who build, install and sell stair parts and stairways in this country, it is our purpose to defend, test, evaluate and promote products and standards that insure safety in conjunction with growth and prosperity of our industry.

*For more information about the association or becoming a member either write, call, visit our website or [Click Here](#).*

### **The Stairway Manufacturers' Association**

657 Quarry St., Ste.3

Fall River, MA 2723

Toll Free: 877-500-5759

Website: [www.stairways.org](http://www.stairways.org)

Email: [SMA@stairways.org](mailto:SMA@stairways.org)

